

# NXT

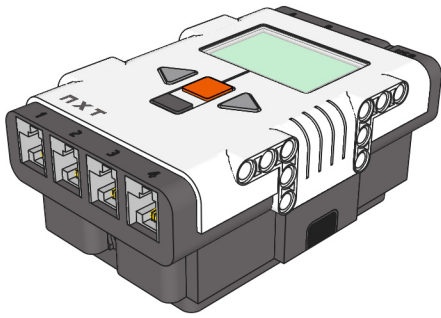

**NXT**

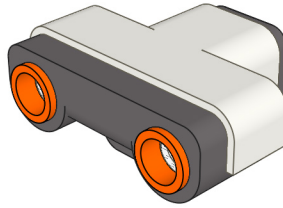

**DISTANCE SENSOR**

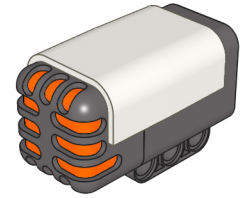

**SOUND SENSOR**

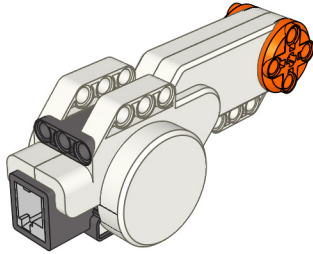

**MOTOR**

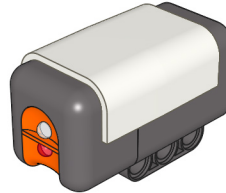

**LIGHT SENSOR**

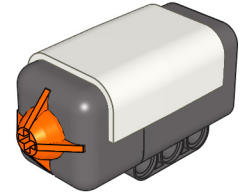

**TOUCH SENSOR**

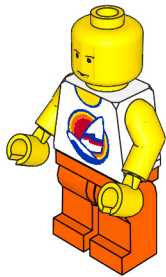

**MINIFIG**



**HAT**



**HAIR**

## WIRES



20 cm



35 cm



50 cm

## BELTS

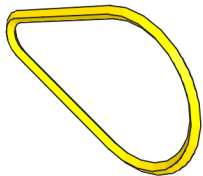

**LARGE**



**MEDIUM**

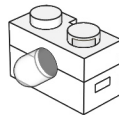

**LIGHT**

## BALLS

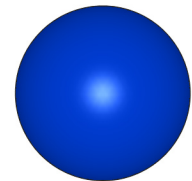
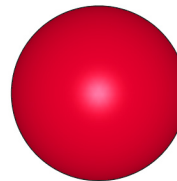

## WHEELS



**THIN TIRE**

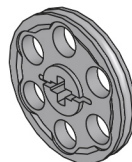

**THIN**

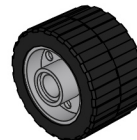

**SMALL**



**LARGE**

# BRICKS

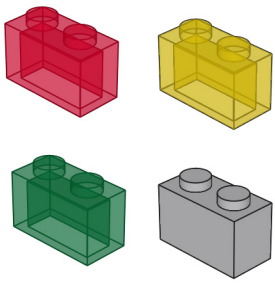

1 x 2

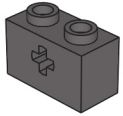

1 x 2 w/  
AXLE HOLE

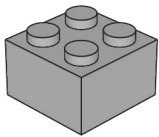

2 x 2

# LIFT ARMS

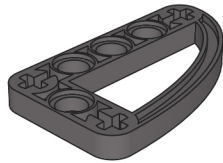

3 x 5 PLATE

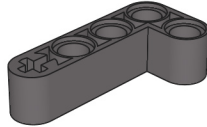

2 x 4

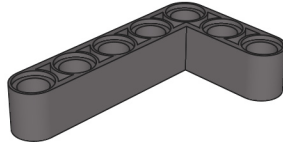

3 x 5

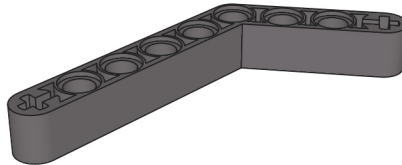

4 x 6

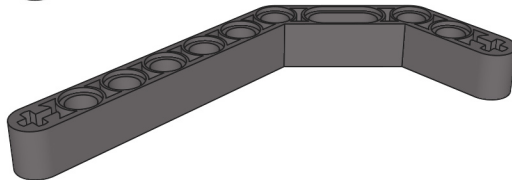

3 x 7

# PLATES



1 x 2 TILE

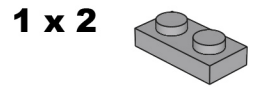

1 x 2

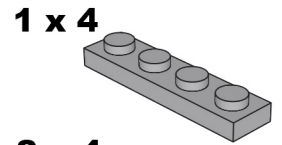

1 x 4

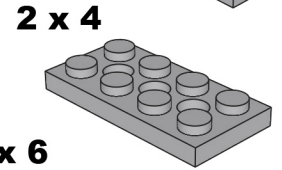

2 x 4

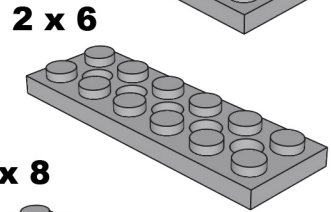

2 x 6

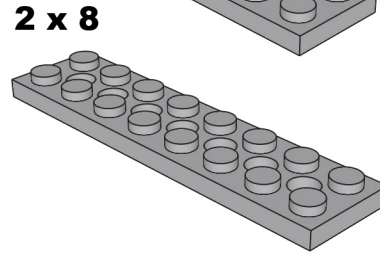

2 x 8

# BEAMS

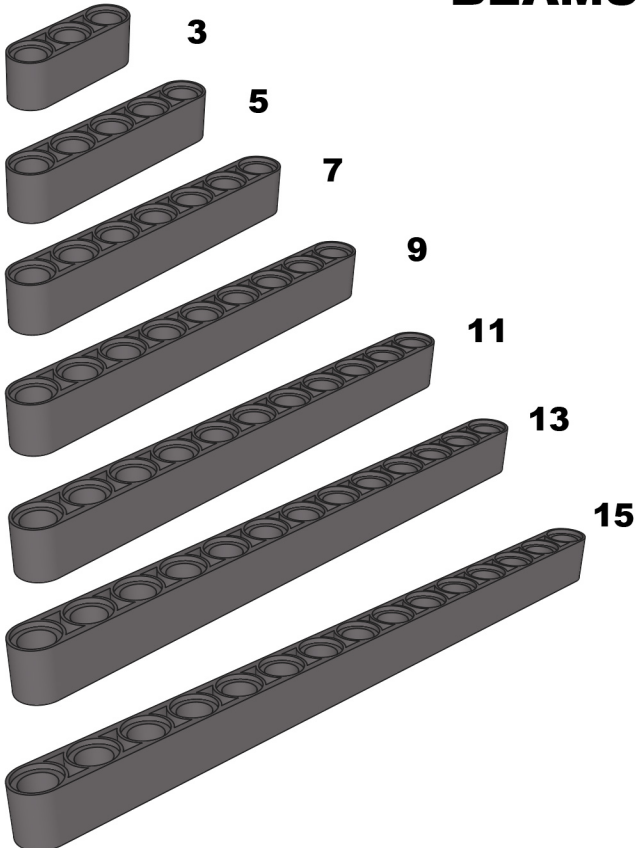

3

5

7

9

11

13

15

# BEAMS WITH STUDS

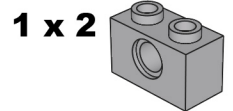

1 x 2

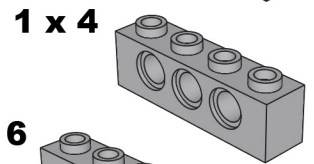

1 x 4

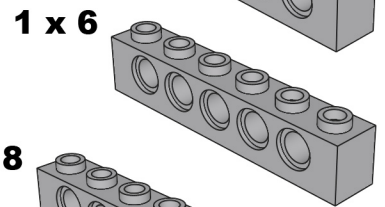

1 x 6

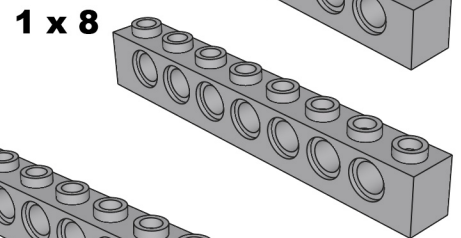

1 x 8

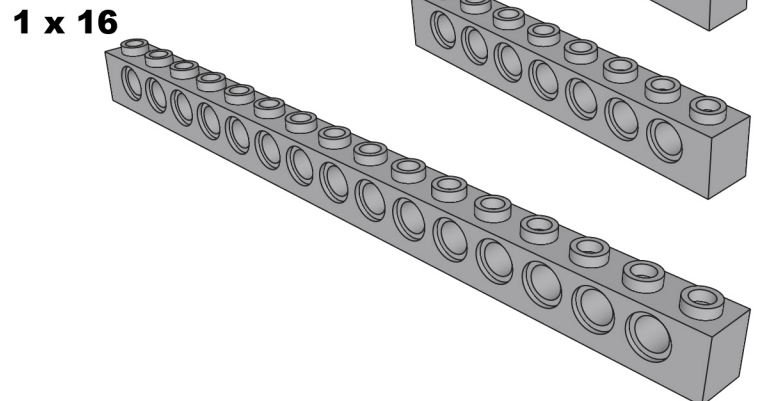

1 x 16

# GEARS

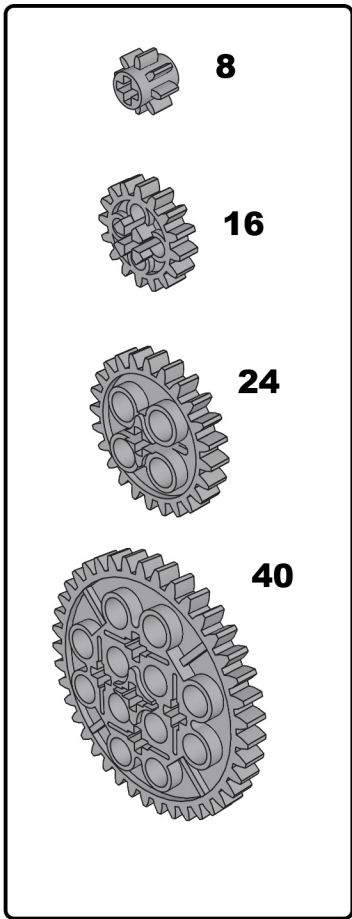

# WIDE GEARS

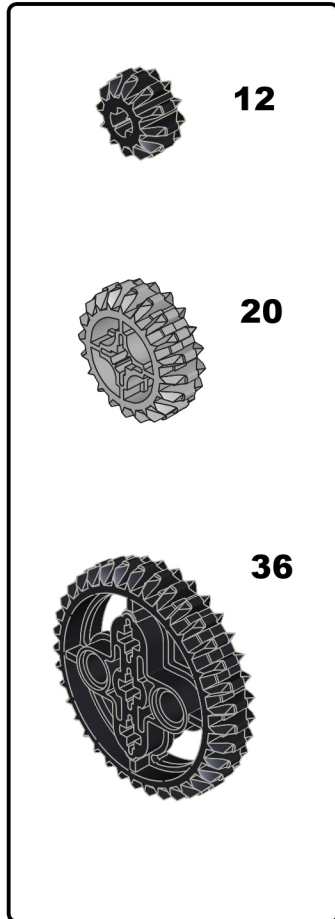

# PEGS

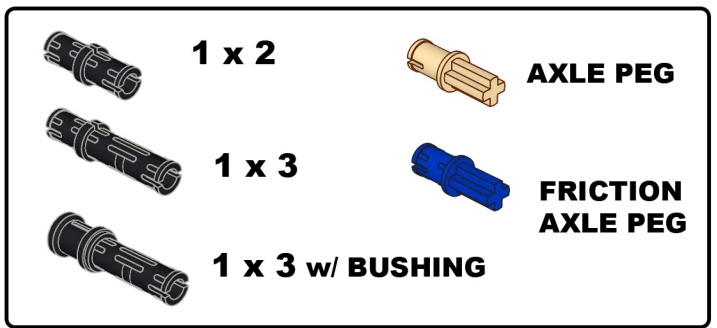

# JOINERS

## AXLE

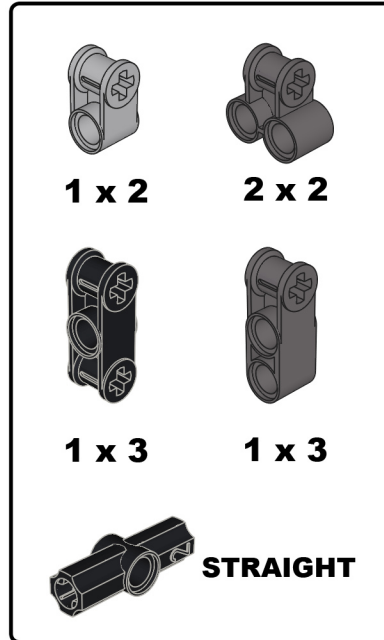

## BEAM

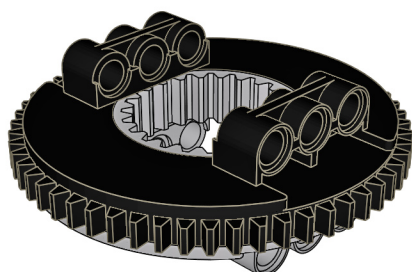
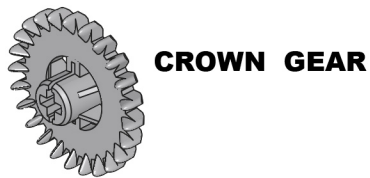
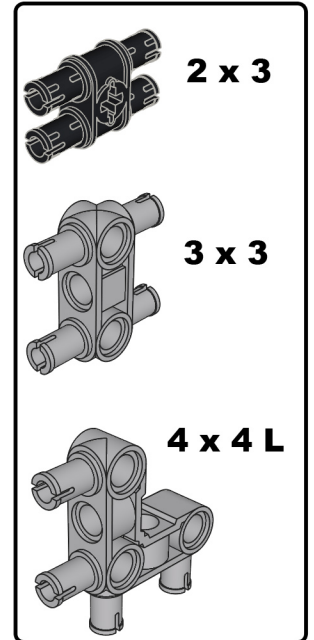

# AXLES

